

Plasma Direct Installation Instructions for BRZ / FR-S

Thank you for your purchase. Please read this instruction carefully for a proper and safe installation.

Safety Instructions

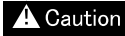

1. Installation should be made only on designated vehicles and models.
2. Never modify or dismantle this product.
3. The vehicle should be on a flat surface, with tires blocked to prevent the vehicle from rolling.
4. The engine should be off and completely cooled. Be sure the ignition key is not inserted.
5. The negative terminal from the battery should be disconnected. Note that this may cause the security alarm to activate. Consult the vehicle owner's manual to prevent this from occurring.
6. The engine should be in good operating condition. Any sign of defects should be corrected before installation.
7. Make sure you have adequate ventilation before running the engine.
8. Installation should be performed by a professional mechanic.
9. If the engine performance was previously boosted through modification of the ignition timing or air/fuel ratio, it may require readjustment following installation of the product.
10. If any defects are found in the product, discontinue using it immediately and contact the dealer where you purchased the product or us.

Parts Included

Plasma Direct coils 4P

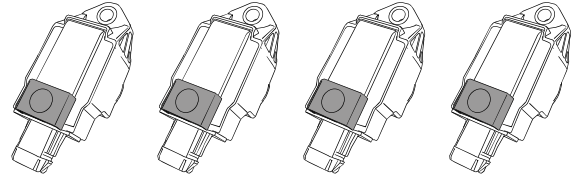

Installation Procedure

- 1 Remove the components (a) - (d) as illustrated below.

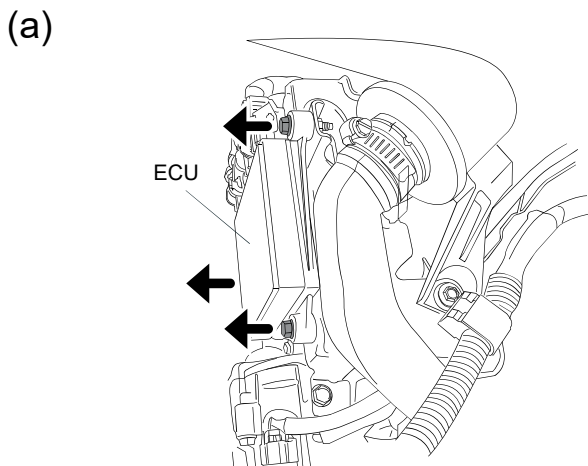
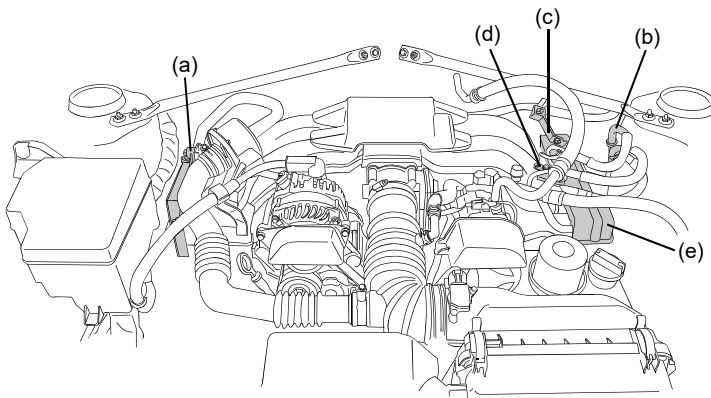

Do not disconnect the ECU connector when removing the ECU.

(b)

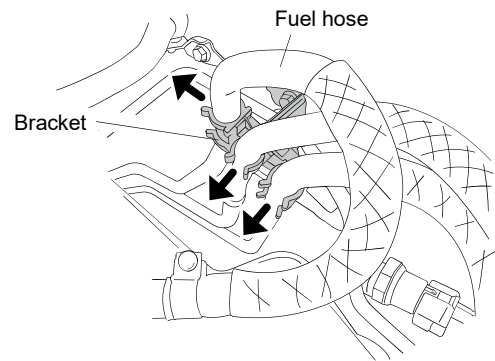

(c)

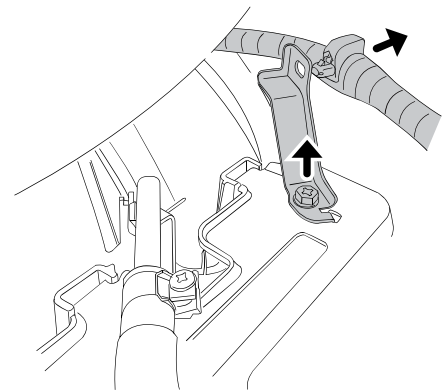

(d)

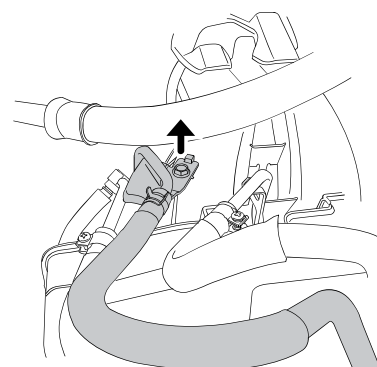

(e)

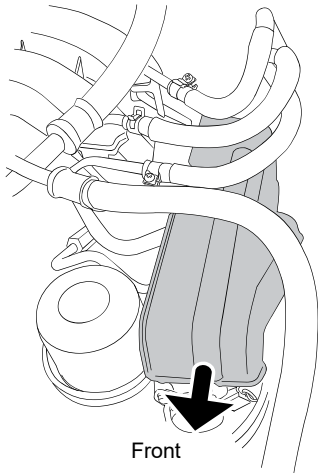
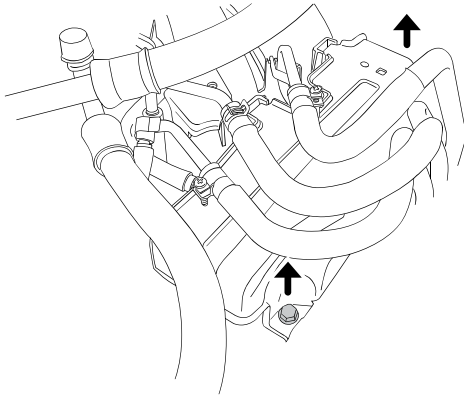

2 Remove the ignition coils from the engine, and disconnect the coil connectors.

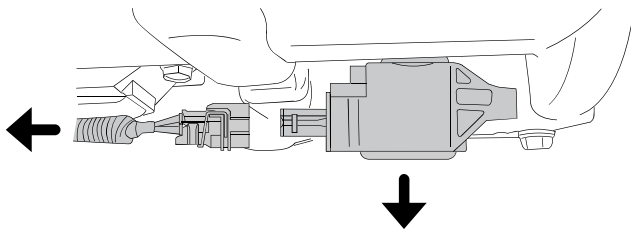
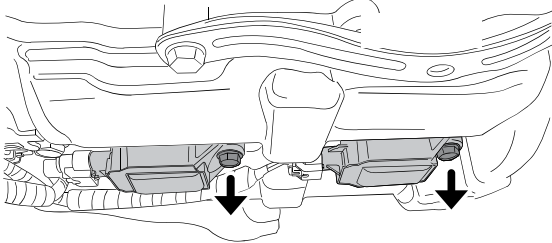

How to disconnect the coil connector

Unlock the fixing tool pushing it in the direction of the arrow.

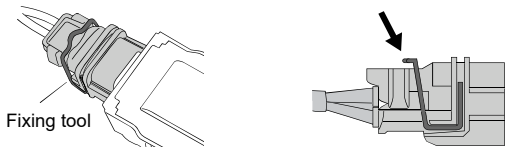

3 Remove the plug boots from the ignition coils, and attach them to the Plasma Directs.

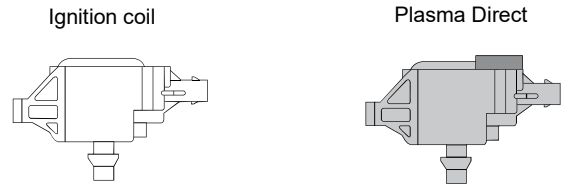

(1) Remove the plug boot.



(2) Attach the plug boot to the Plasma Direct.



Plug boot

4 Install the Plasma Directs to the engine, and connect the coil connectors.

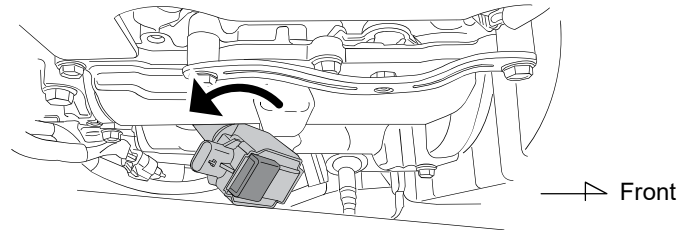

5 Mount back properly all the components you removed for the installation.

PD4004902R
BRZ/FR-S 2/2



OKADA PROJECTS Inc.
2-3-5 Kitamikata, Takatsu-ku, Kawasaki-shi Kanagawa 213-0005 Japan
www.okadaprojects.com info@okadaprojects.com

All rights reserved. Reproduction in any form without written permission from Okada Projects is prohibited.