

Instruction Manual P/N:FM92001

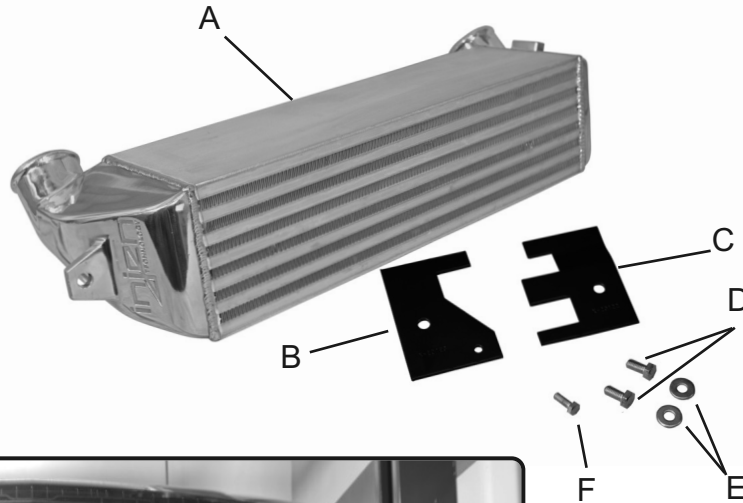

Vehicle Application:
 Make: **Ford**
 Model: **Mustang EcoBoost**
 Year: **2015-2017**
 Engine: **2.3L 4-cyl. Turbo**

Item	Qty	P/N	Discription
A	1	#SES9200IC	Intercooler
B	1	#20123	Bracket
C	1	#20122	Bracket
D	2	#6018	M8 Bolts
E	2	#6011	1/4" washer
F	1	#6005	M6 Bolt

- TOOLS REQUIRED**
- Pliers
 - Ratchet
 - 13mm Socket
 - 10mm Socket
 - 8mm nut drive
 - Allen key
 - Flat Blade Screwdriver
 - Phillips Screwdriver
 - 5.5mm nut driver
 - 7mm nut driver

WARNING: FAILURE TO FOLLOW INSTALLATION INSTRUCTIONS AND NOT USING THE PROVIDED HARDWARE MAY DAMAGE THE INTERCOOLER SYSTEM, ENGINE AND COMPONENTS!!!
***Do not attempt to install the intercooler system while the engine is hot.**
 Severe burn could result from touching hot engine components!

Report any defective or missing parts to the authorized Injen dealer you purchased this product from. Before installing any parts of this system, please read the instructions thoroughly. If you have any questions regarding installation, please contact your Injen Technology dealer. Installation DOES require some mechanical skills. A qualified mechanic is always recommended.

Instruction Manual P/N:FM92001



1. Remove the 8 plastic rivet clips to remove the radiator support cover.



2. Remove the 5 - 8mm screws on top of the bumper.

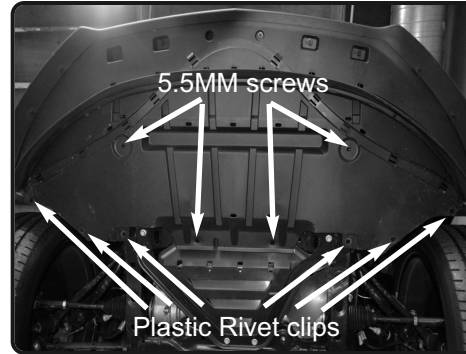

7. Carefully raise the vehicle up and unscrew the 4-5.5mm screws and remove the 6-plastic rivet clips from the front bumper tray



3. Remove the 3 plastic rivet clips from the side of the bumper on the wheel well cover. Repeat for the other side.



4. Pull back on the wheel well cover to access the 7mm screw holding the bumper to the fender in place. Repeat for the other side.



5. Once you have removed the screws from figure 4, carefully pull out on the side of the bumper to detach the front bumper from the bumper bracket.



6. Remove the last 5.5mm screws from the front bumper located at the top on the ends of the bumper near the headlight.



7. You may now continue to remove the front bumper cover from the vehicle.



8. Disconnect the fog light harnesses.

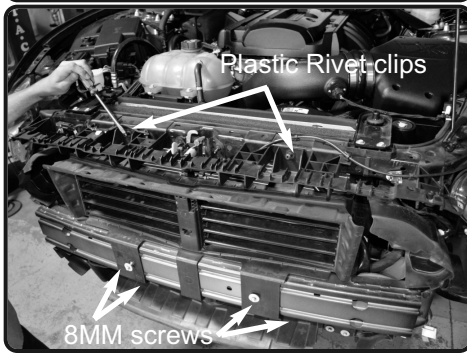

9. Remove the two plastic rivet clips on top of the active shutter and 4 - 8mm screws in front and below the active shutter

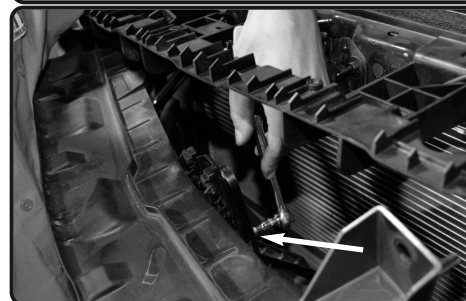

10. Pull the active shutter forward and remove the 5.5mm screw from the active shutter bracket. Detach the active shutter bracket from the active shutters. Disconnect the harness to the active shutter motor.

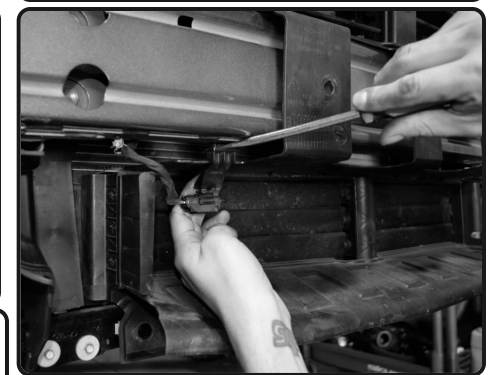

11. Unclip the ambient air temp sensor from the bumper support

Instruction Manual P/N:FM92001



12. You may now remove the entire shutter.

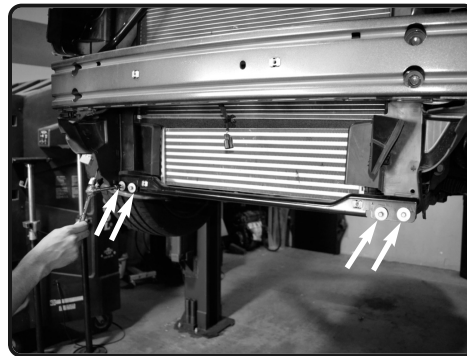

13. Remove the four 8mm bolts from the lower support bar and then remove the bar.



14. From the drivers side, disconnect the MAF sensor harness from the OE intercooler. Then loosen the clamp on the OE charge hose and pull the hose from the OE intercooler.



15. Remove the 10mm bolt from the front left side of the OE intercooler.

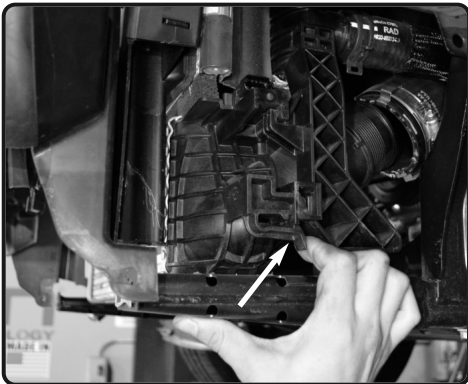

16. Pull the securing tab on the right side of the OE intercooler to detach the OE intercooler from the front support



17. Loosen the clamp and detach the OE charge hose from the OE intercooler on the right side.



18. Locate and detach the two plastic locking tabs on each side of the AC condenser. This will allow you to lift the AC condenser up 1" to allow removal of the OE intercooler

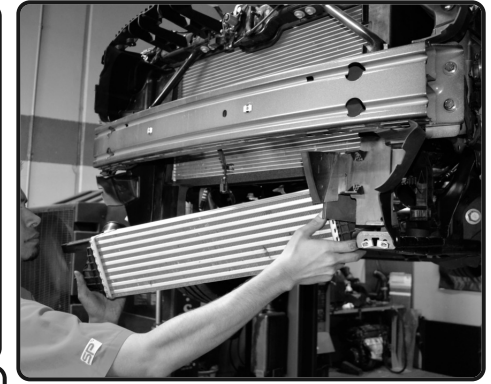

19. Remove the OE intercooler. Having an assistant pull the side plastic covers will help aid in a easier removal.

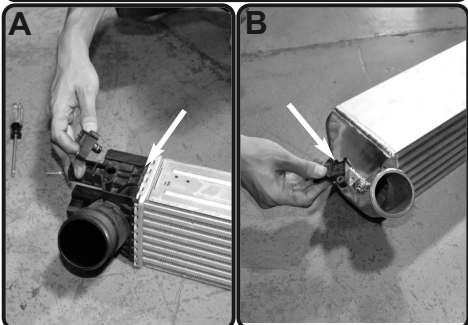

20. (A) Remove the MAP sensor from the OE intercooler and (B) then re-install it on the Injen intercooler and secure it with a supplied M6 bolt.



21. Place the Injen Intercooler into position. You may need an assistant to hold the intercooler while you place the brackets.

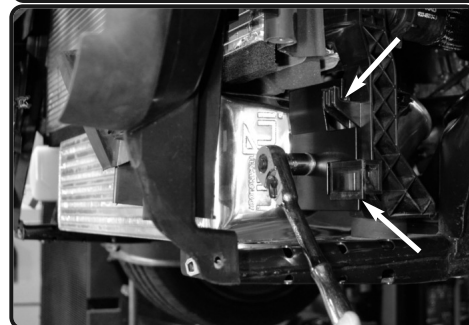

22. Slide the supplied #20122 bracket onto the left factory intercooler support tabs and then attach the intercooler with a M8 bolt and washer. Leave the bolt loose for now.

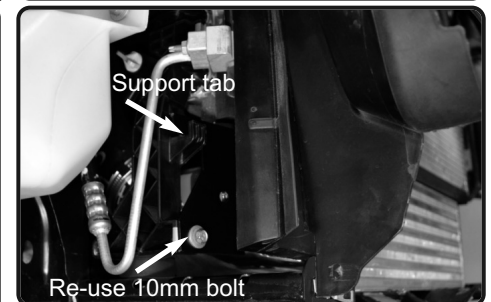

23. Slide the supplied #20123 bracket onto the right factory intercooler support tab and then secure the bracket with the OE 10mm bolt and then attach the intercooler with a M8 bolt and washer.



20. Make your final adjustment on the Injen intercooler for best fitment and then secure both the 8mm bolts on the brackets to secure the intercooler.



21. Reconnect both OE charge hoses to the Injen intercooler and then secure the clamps.

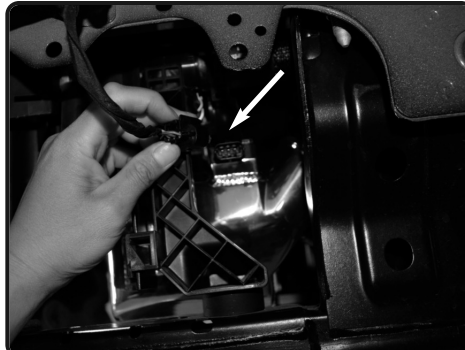

22. Reconnect the MAP sensor harness to the MAP sensor on the Injen intercooler from figure 20.



23. Your Injen intercooler installation is now complete. Make your final adjustment and make sure all your nuts, bolts and clamps are secure. Reinstall the rest of the bumper components in reverse order.

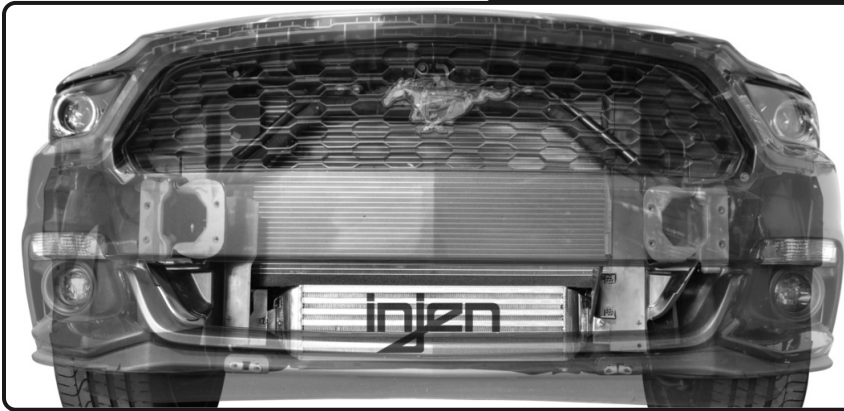

Congratulations! You have just completed the installation of the Injen intercooler system. Periodically, check the alignment of the intercooler, normal wear and tear can cause nuts and bolts to come loose. **Note: Check clearance and adjust if needed! Failure to check the alignment and adjust the intercooler can cause damage that will void the warranty. Injen Technology is not responsible for any damages caused by/from improper installation.**

Test Drive:

1. With the transmission in neutral or park and the parking brake engaged, start the engine. Listen for air leaks or odd noises. If air leaks are detected, secure hoses and connections. For any odd noises, inspect entire system for cause and adjust intercooler as needed. The Injen intercooler will function identically to the factory system but will be more powerful.
2. Perform a road test. Listen for odd noises or rattles and fix as necessary.
3. If there are no issues, continue to enjoy your added performance from the Injen performance intercooler kit.
4. Injen Technology recommends you periodically check clearance and adjust if needed! Failure to check the alignment and adjust their intercooler can cause damage that will void the warranty. Injen Technology is not responsible for any damages caused by/from improper installation.

1. Upon completion of the installation, reconnect the negative battery terminal before you start the engine.
2. Align the entire intercooler system for the best possible fit. Once the intercooler has been properly fitted continue to tighten all nuts, bolts and clamps.
3. Periodically, recheck the alignment of the intercooler system and make sure there is proper clearance Failure to follow proper maintenance procedures may cause damage to the intercooler and will void the warranty.
4. Start the engine and listen carefully for any odd noises, rattles and/or air leaks prior to taking it for a test drive. If any problems arise go back and check the vacuum lines, hoses and clamps that maybe causing leaks or rattles and correct the problem.